

FTF Eagle 56

Designed By: Unknown
Drawing By: Dan Sponholz

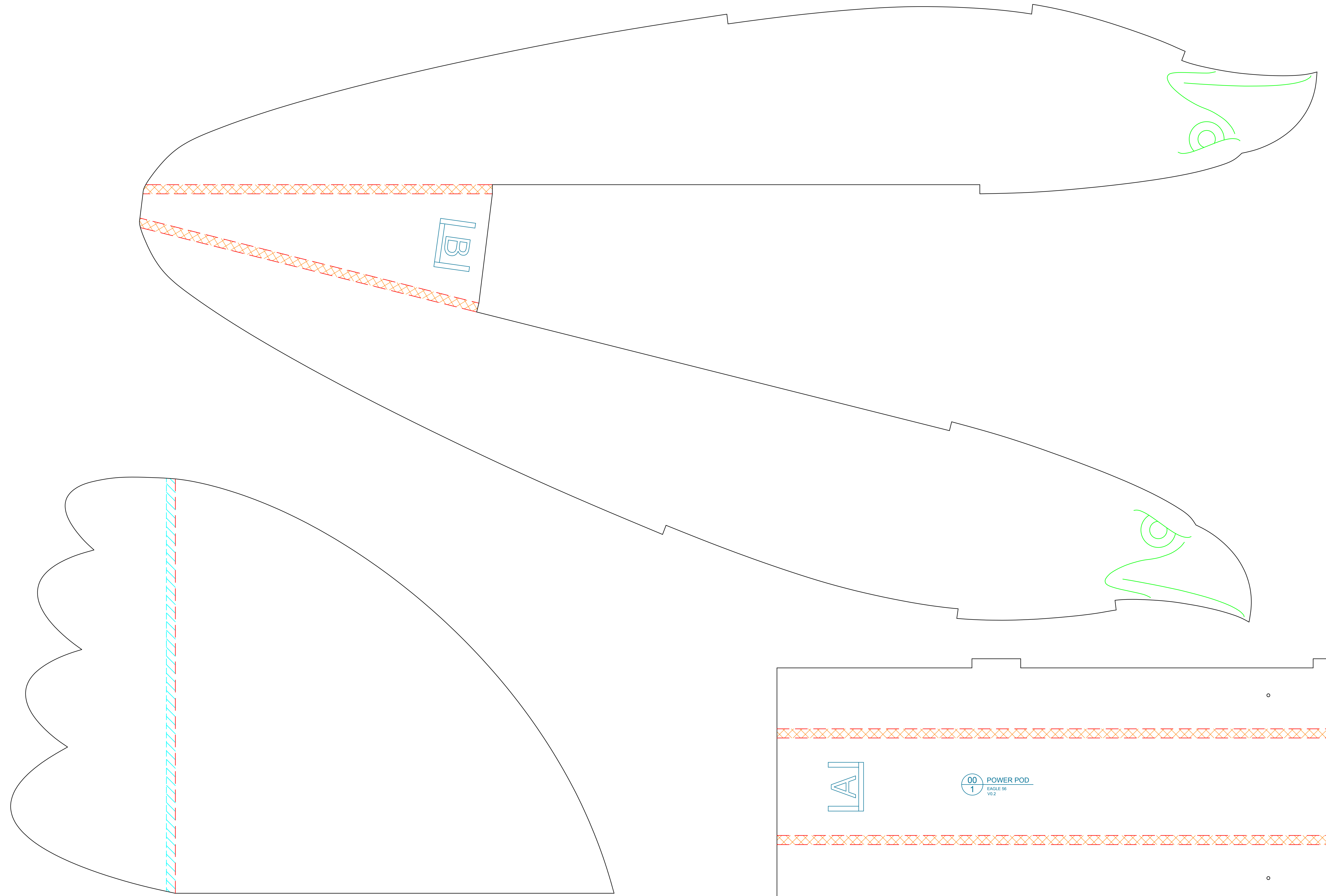

FTF Eagle 56

Designed By: Unknown
Drawing By: Dan Sponholz

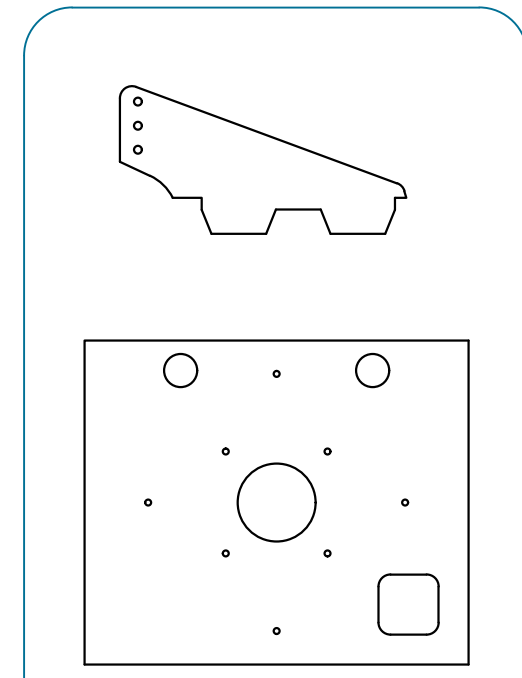
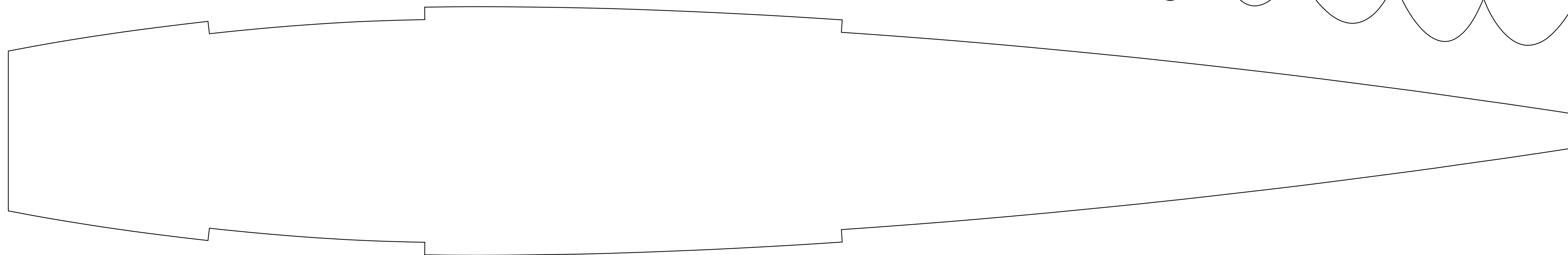
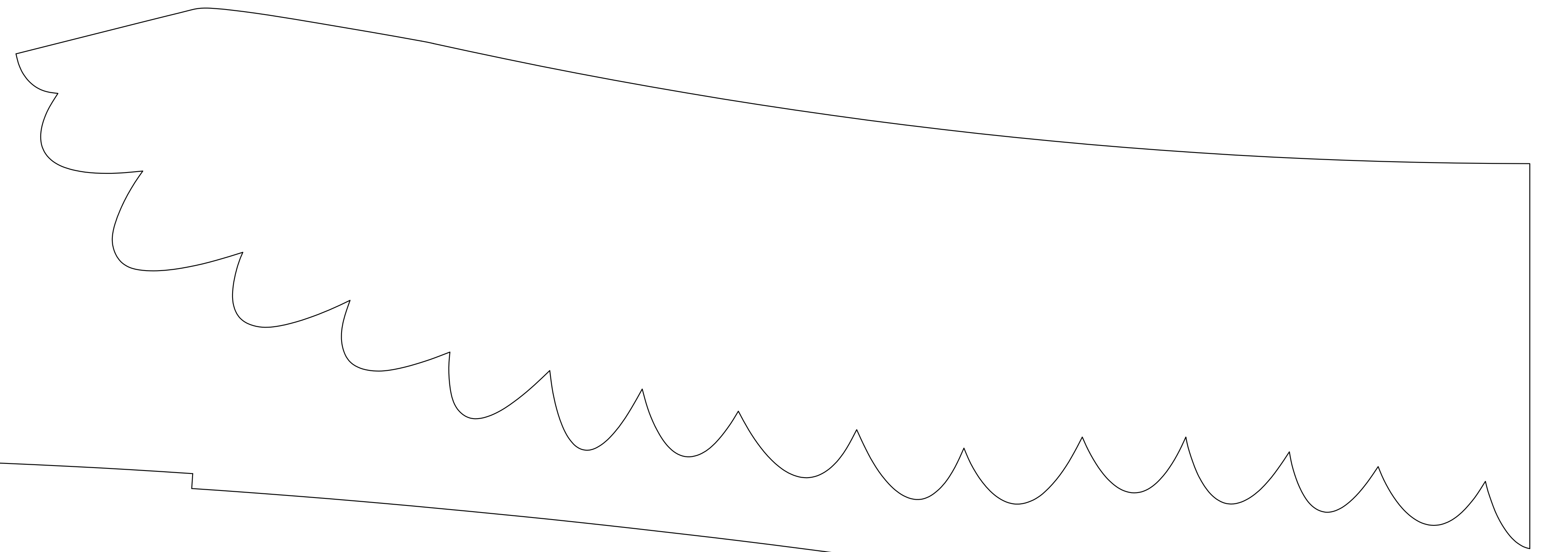
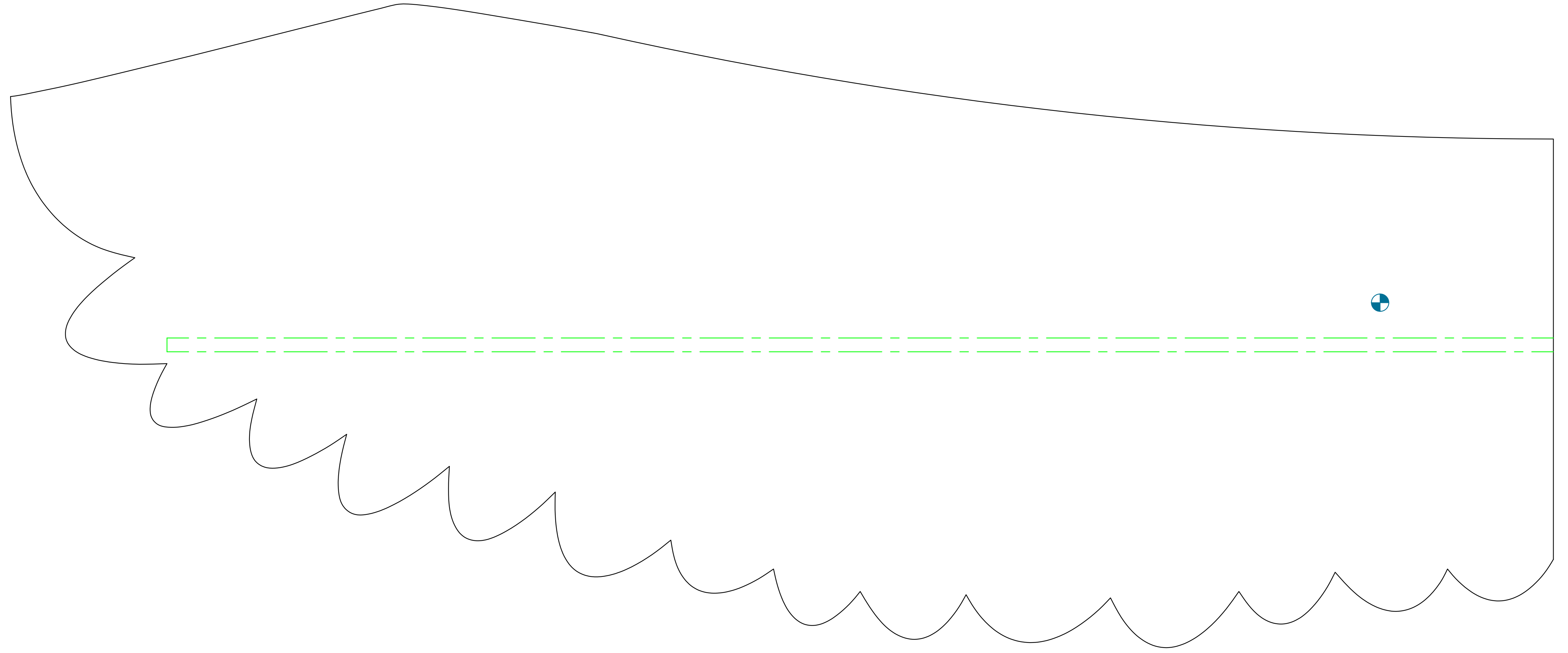
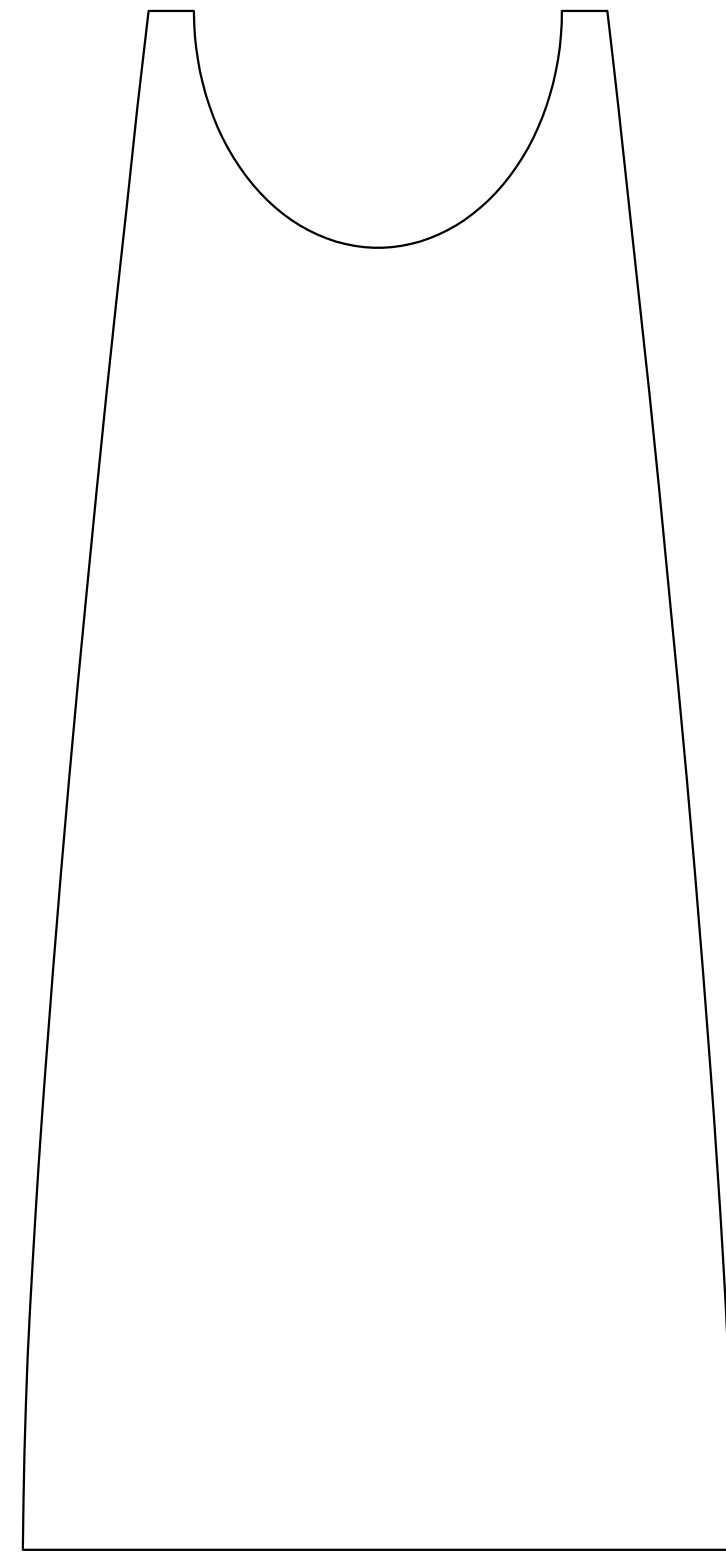

FIREWALL & CONTROL HORN
1/16" (1.5mm) THICK
HOBBY GRADE PLYWOOD

FTF Eagle 56

Designed By: Unknown
Drawing By: Dan Sponholz

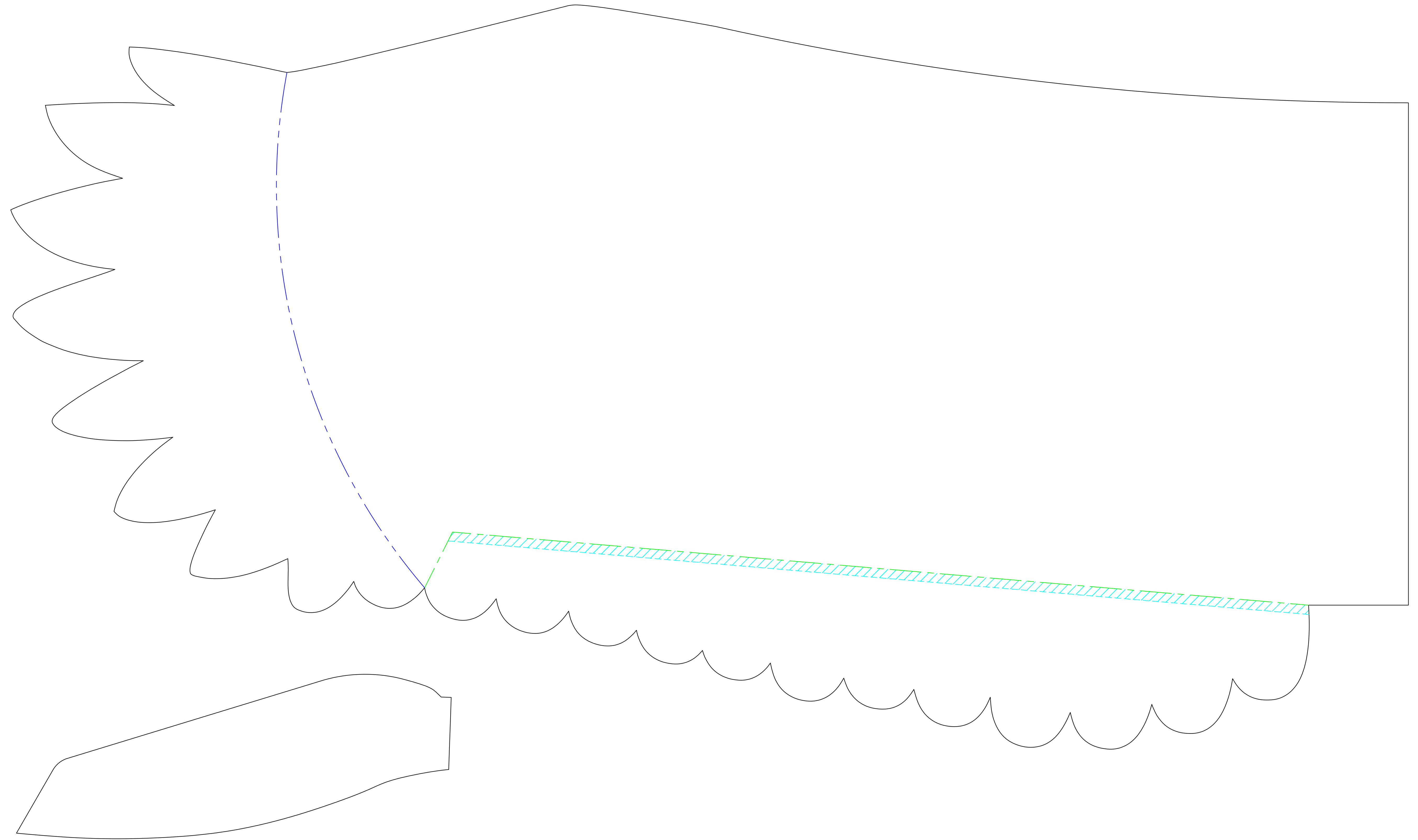

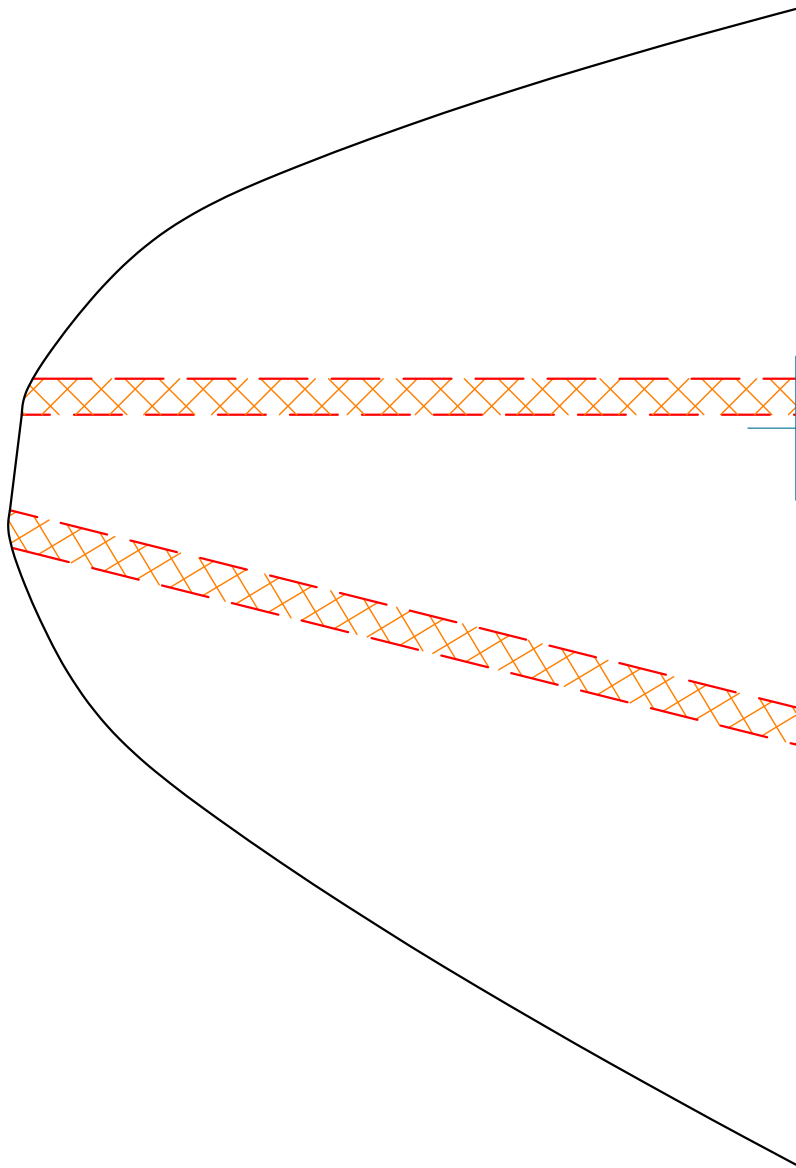

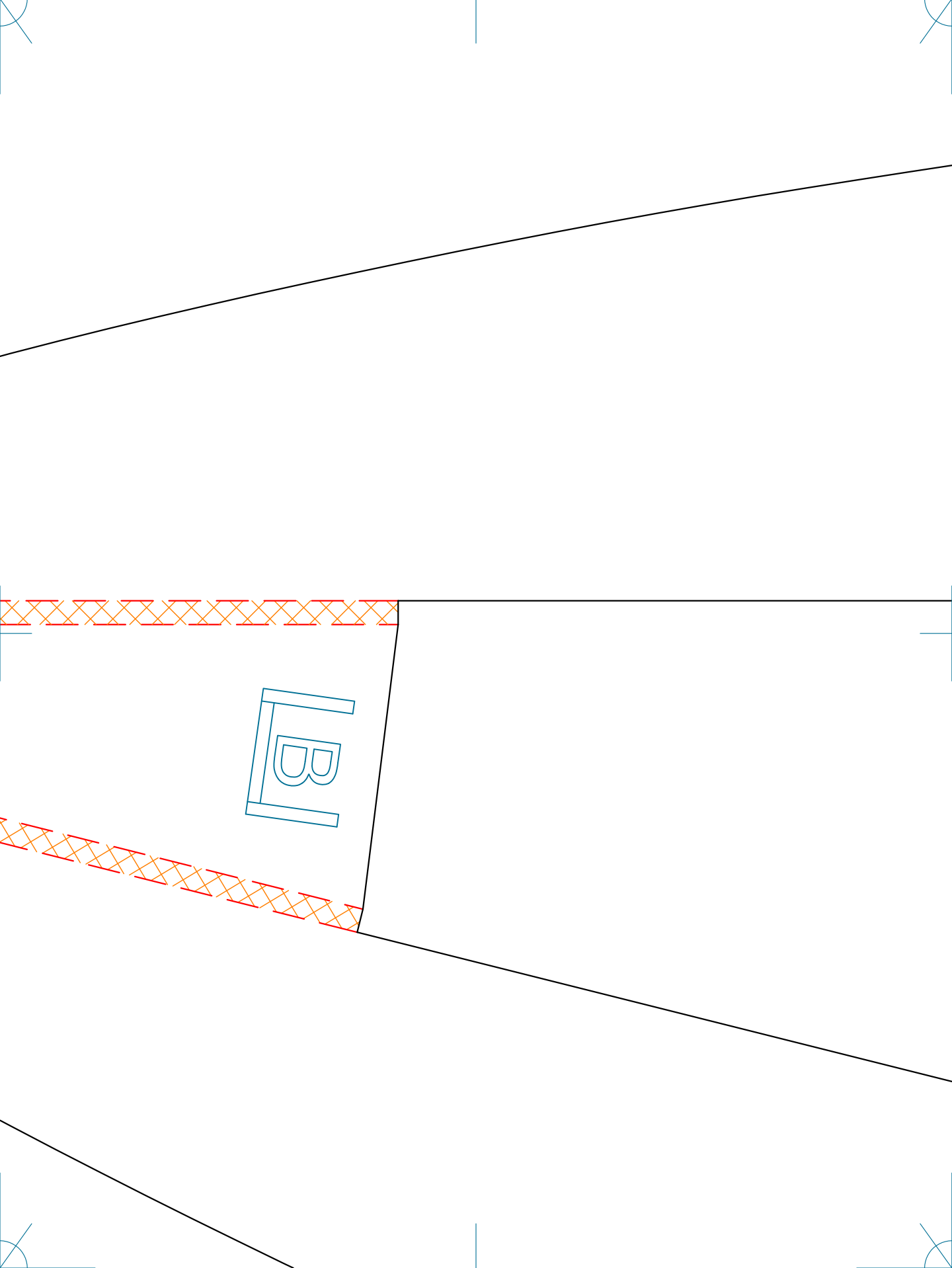

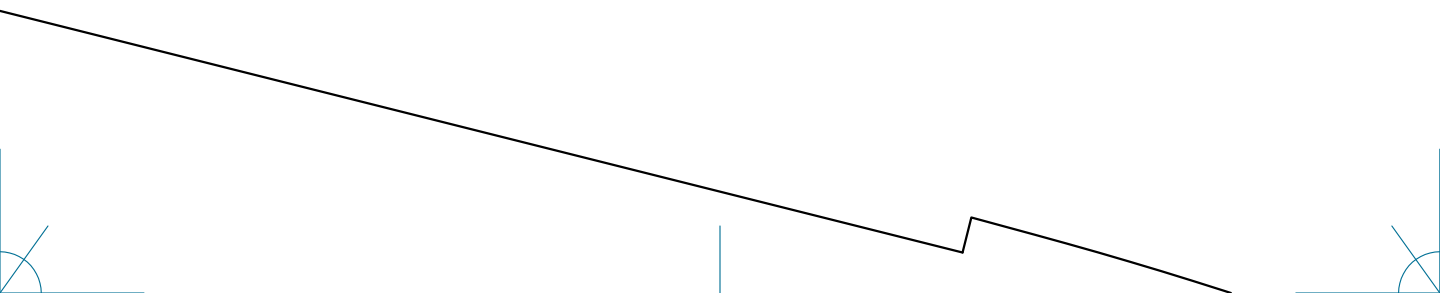
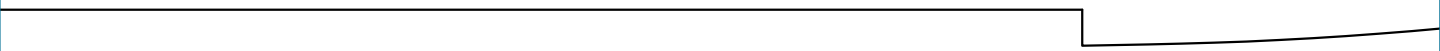

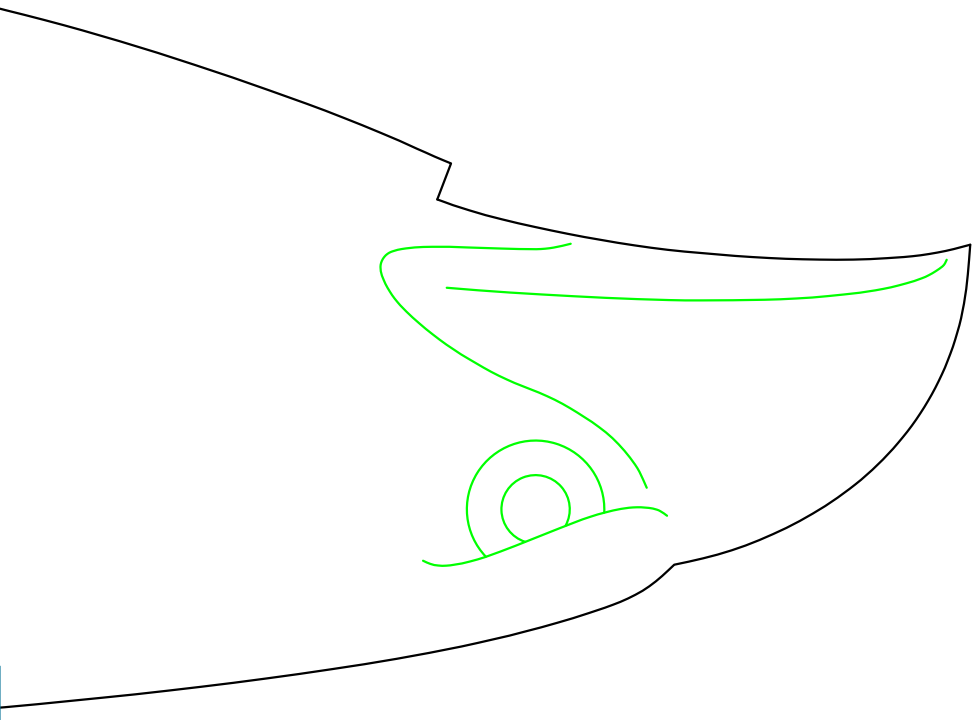

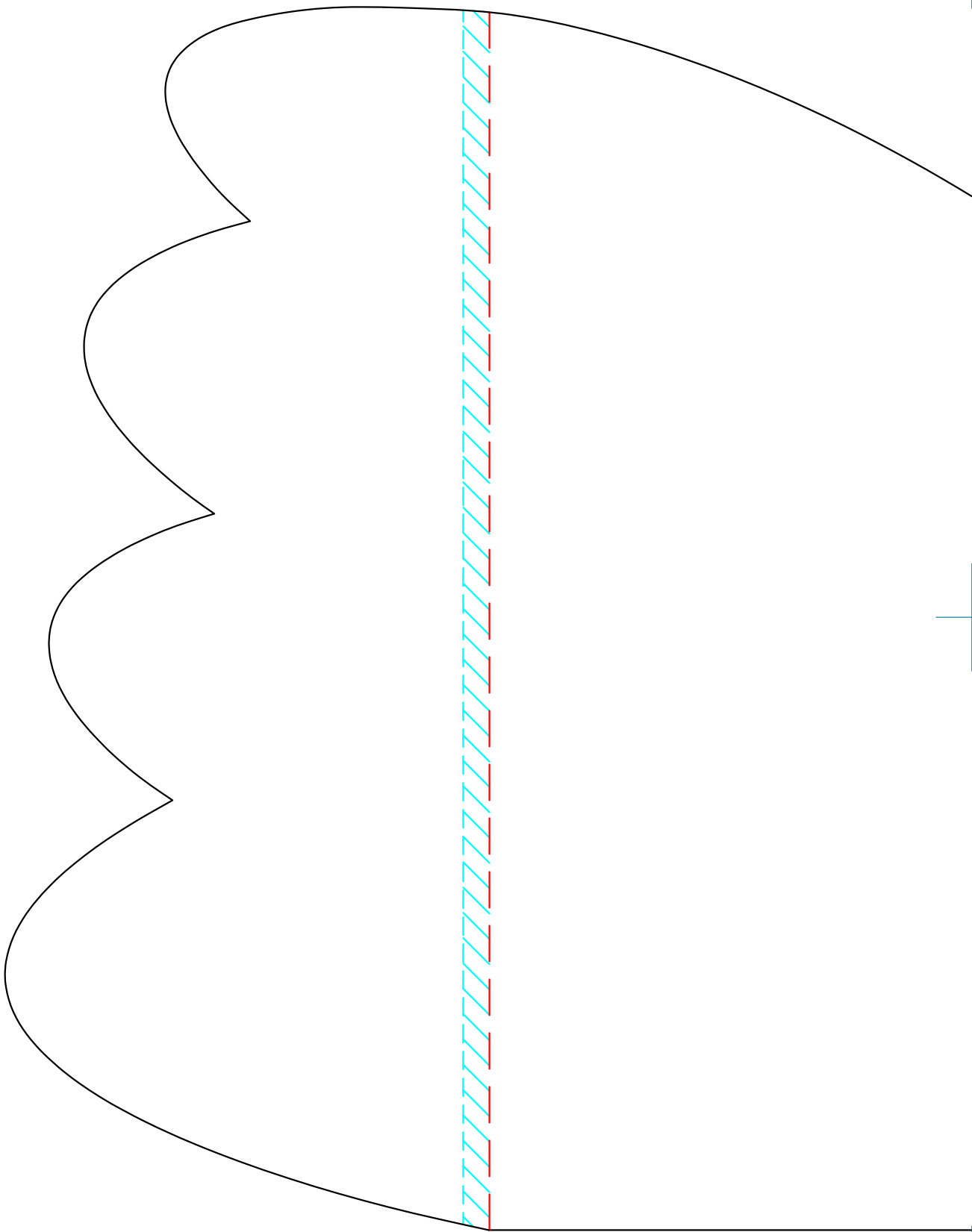



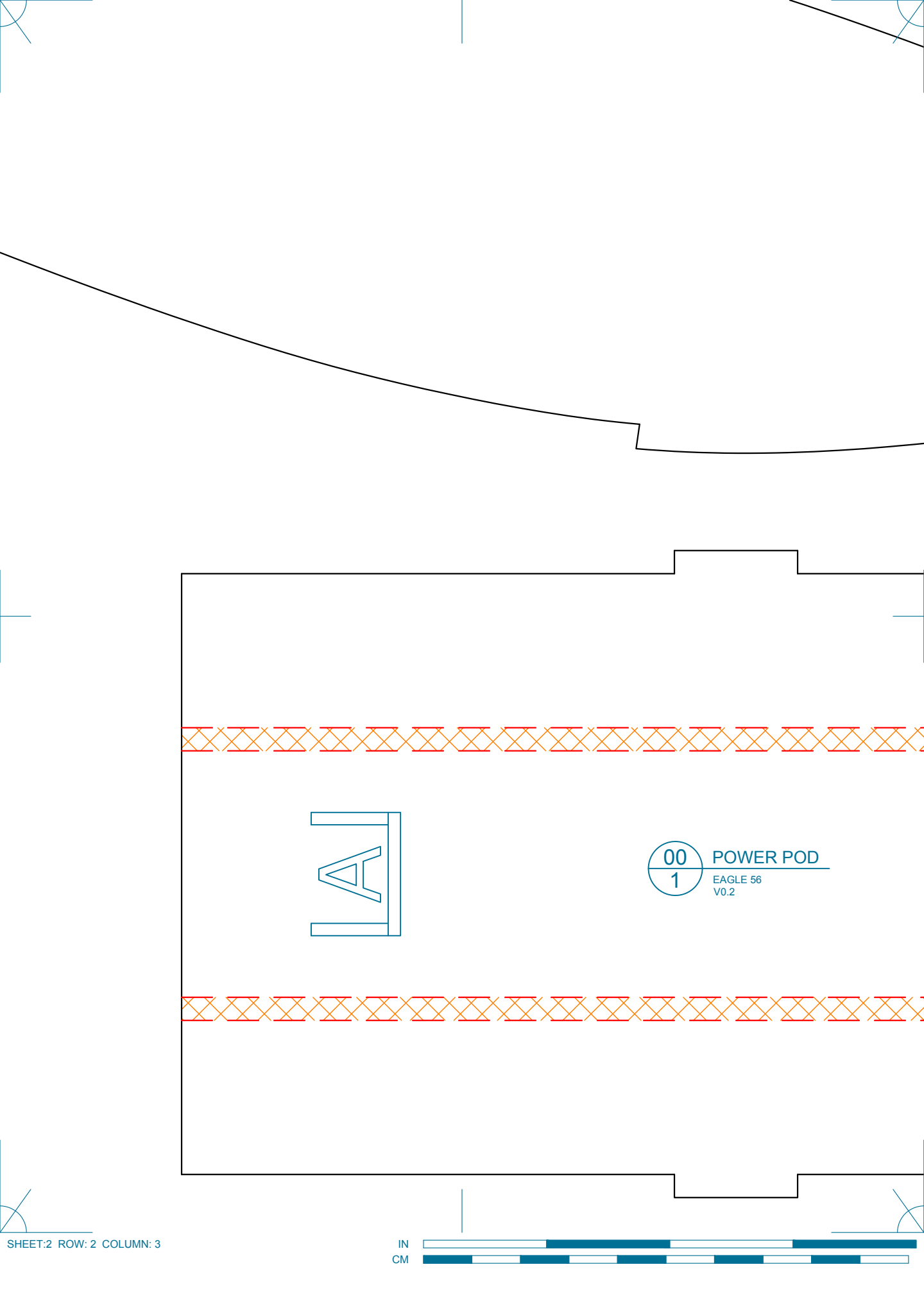

00
1

POWER POD

EAGLE 56
V0.2

